





### Text Tree-Structure Menus ECLIPSE Series

There are several ways for setting parameters in text menus – that depends on the menu:

- **When the submenu allows choosing only one option** or attribute, or parameter from a list, the installer scrolls down to the desired one and confirms his choice with  button. The set option is displayed with a “check” mark in front of it. The exit of the submenu is automatic. See Example 1.

- **When the submenu allows choosing of several options** or attributes, or parameters at the same time then the installer has to scroll down to each one and to enable it with pressing the  button. The set option is displayed with a “check” mark in front of it. The installer has to move to the next option using the arrow buttons and so on. To disable an option, scroll down to it and press  button – the “check” mark will be deleted. When all the desired options are selected, the choice is confirmed with  button. See Example 2.

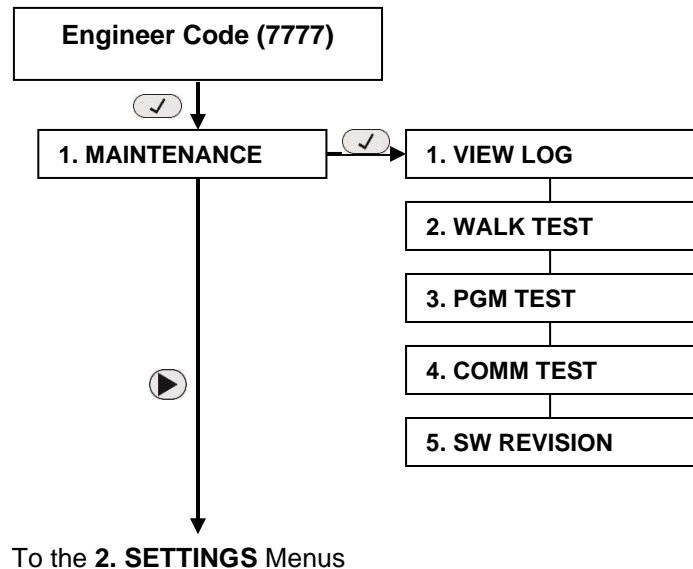

The text menus are available only in operation with LCD keyboard!  
 The provided text tree structures are complete for Eclipse 99 control panel.  
 For resources of supported User Codes, Zones, Areas, etc. in Eclipse 8/8+/16/32 - refer to the detailed programming manual!

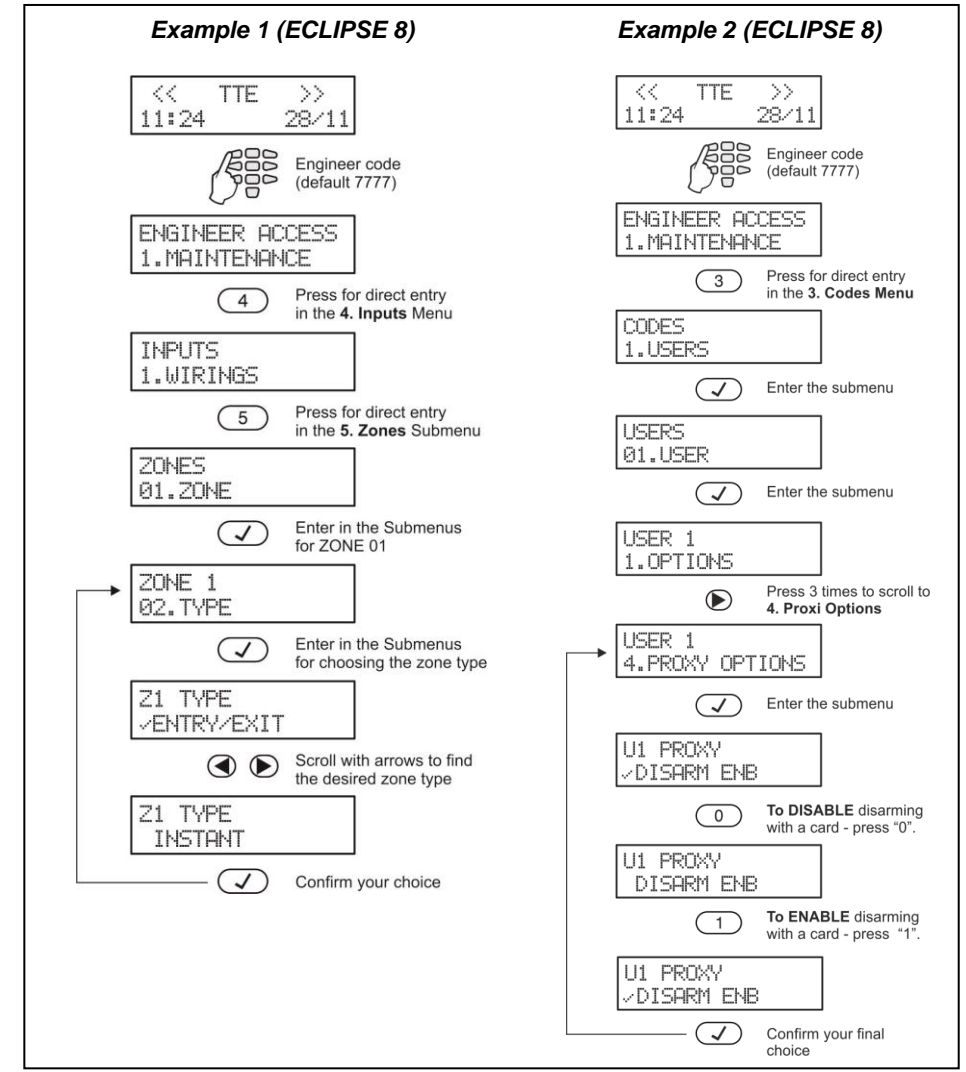

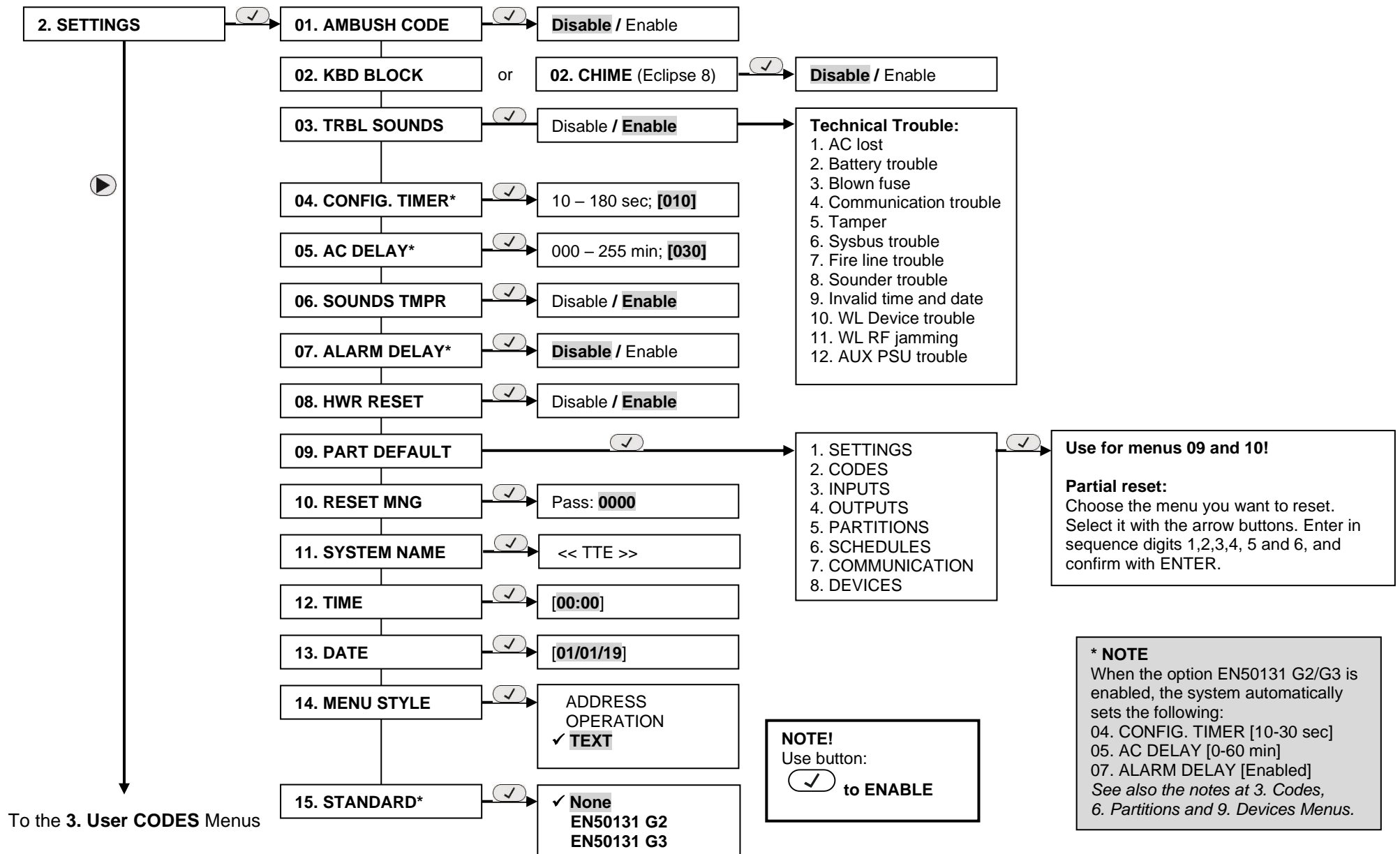

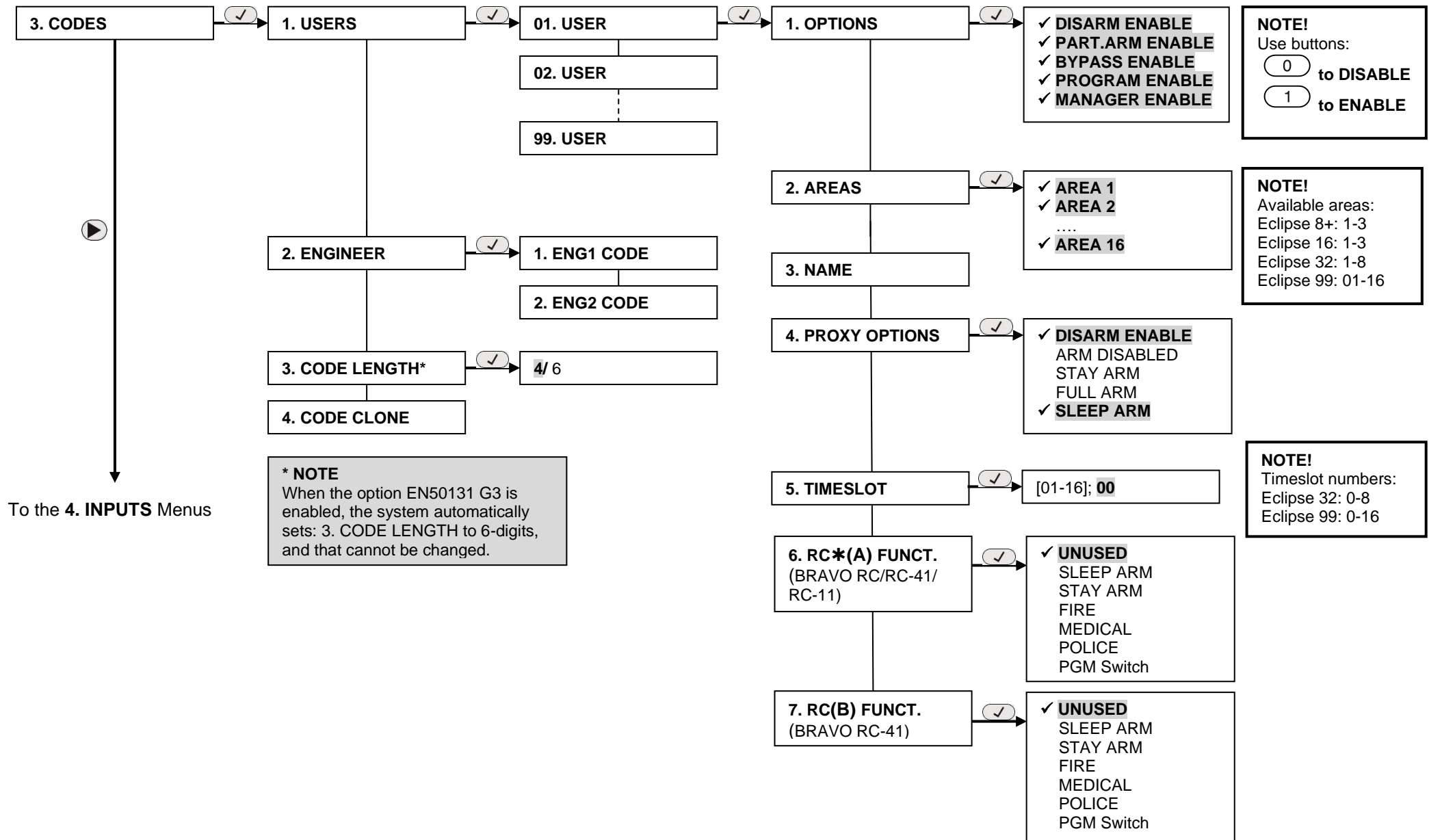

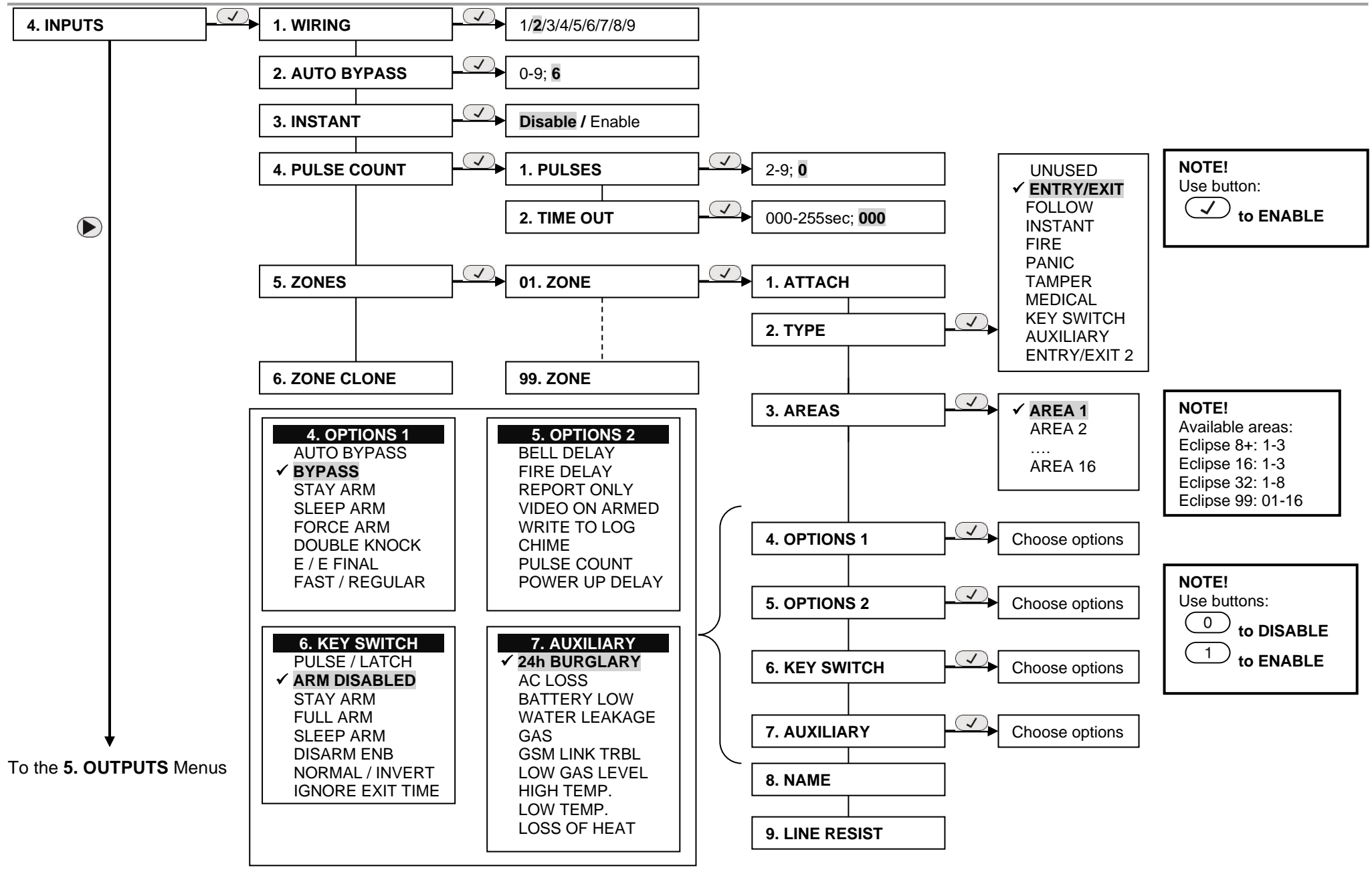

To the 5. OUTPUTS Menus

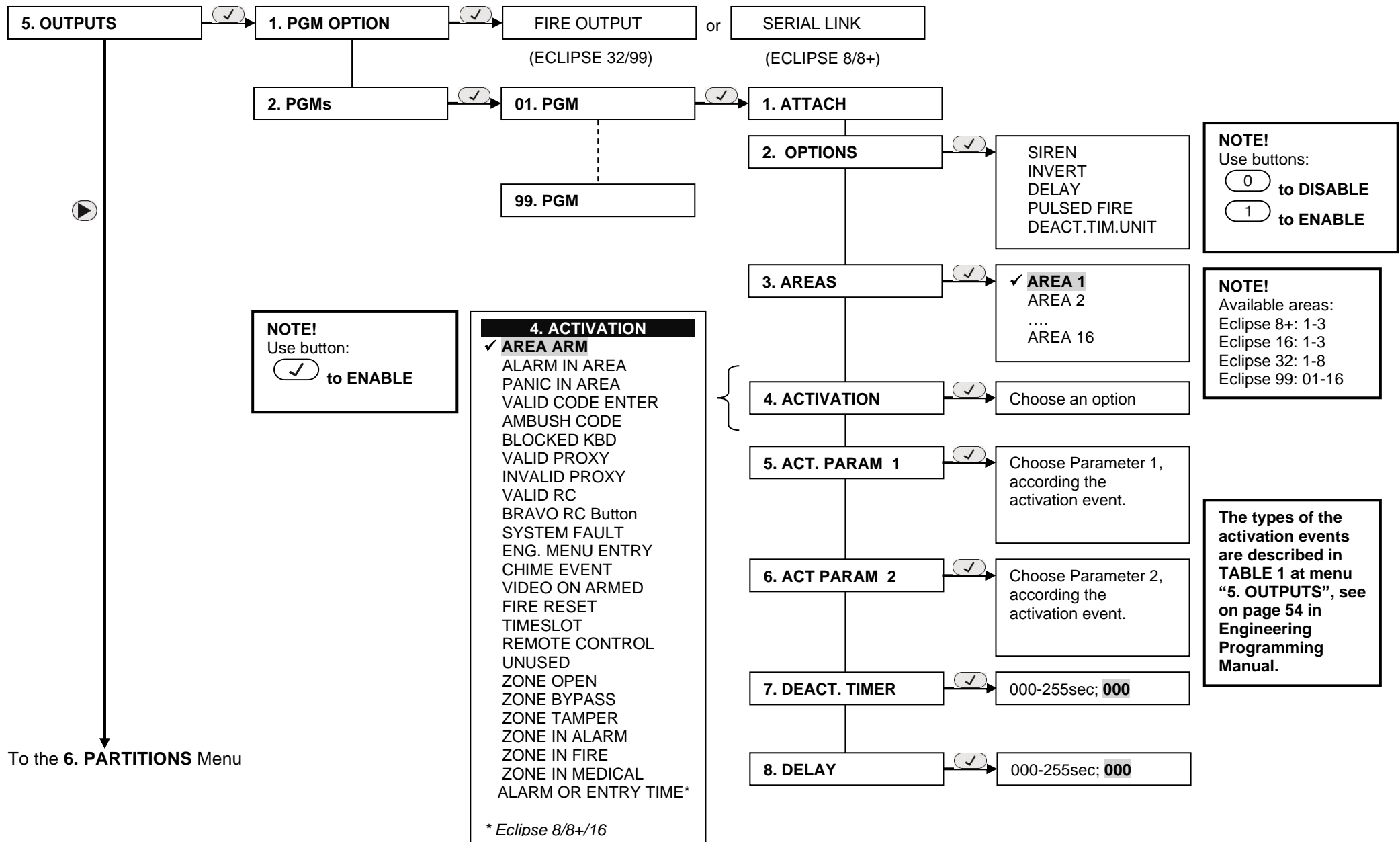

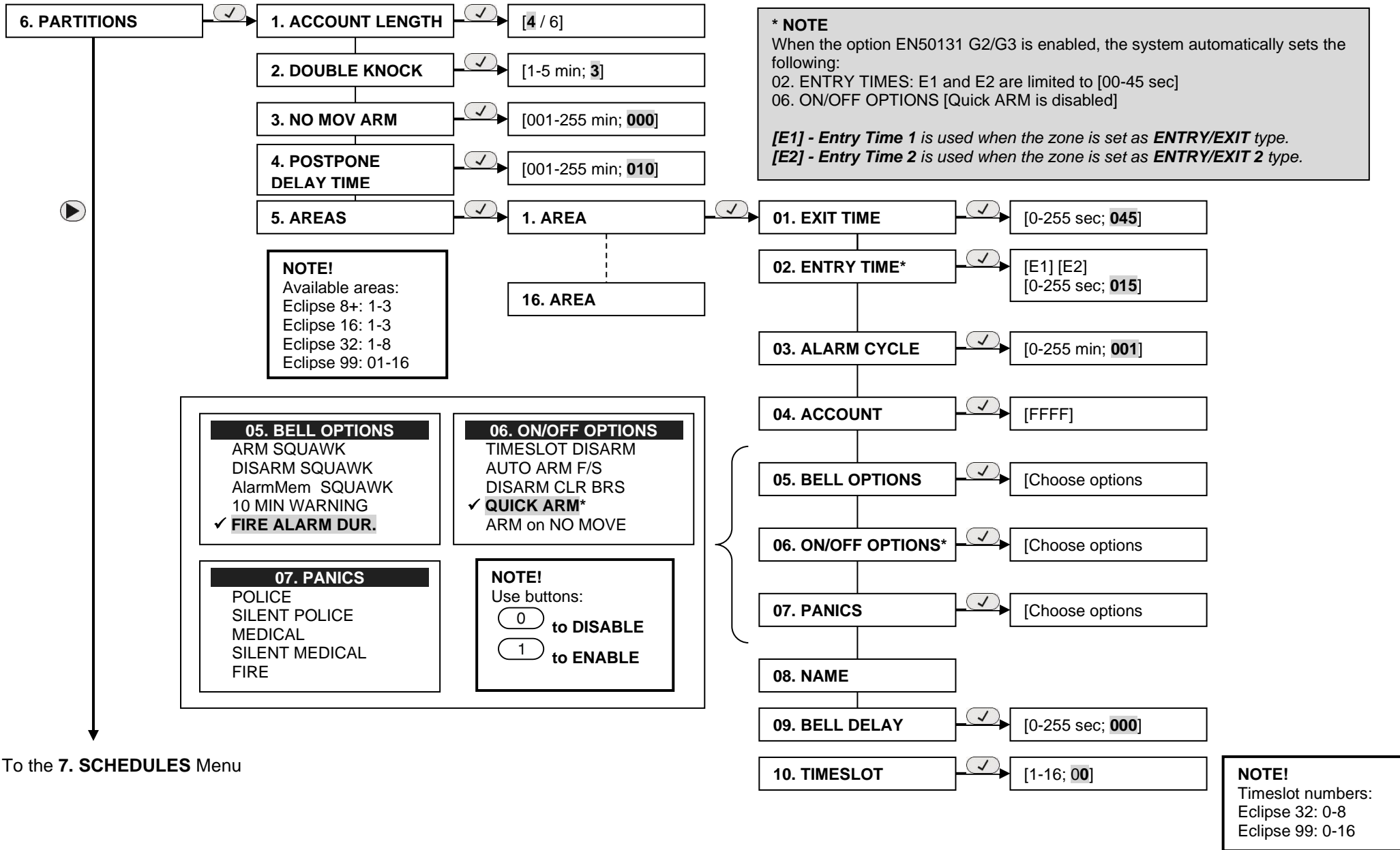

To the 7. SCHEDULES Menu

**Note:** The menus are available only for ECLIPSE 32/99 control panel.

