

## Natron WSS

Wireless addressable  
fire alarm sander and  
strobe



DoP No: 223  
EN 54-3:2001+A2:2006  
EN 54-23:2010  
EN 54-25:2008  
Type A; Open class

# TELETEK

Teletek Electronics JSC  
Address: 2 Iliyansko Shose Str,  
1220 Sofia, Bulgaria

**ATTENTION: Read carefully this installation Instructions before installing the device!**  
**This manual is subject to change without notice!**

## 1. General Description

Natron WSS is a wireless addressable fire alarm sander with strobe, designed for operation with Natron series wireless expander modules\*. The fire sander is equipped with 360° visible strobe LED indication and a built-in sander for signalization in case for announcing of events – fire alarm and finding the place of installation. The operation of the strobe and sander is programmed from the sander's menus (addressable panel or expander module). Natron WSS is a VAD (Visual Alarm Device) compatible with a deep wireless fire base for wall mounting. For prevention of unauthorized disassembling or removing, the sander can be locked to the fire base. The fire sander is equipped also with a tamper switch for self-protection of the box. Natron WSS is designed for indoor installation.

\* Refer to the installation manuals of Natron WE-C, Natron WE-A and Natron WE-A/C wireless expander modules for detailed information about the programming menus and other details.

## 2. Technical Specifications

Communication range with expander module .....	1500m
Battery power supply .....	4 x CR123A 3V
Battery life .....	~8 years
Radio frequency .....	868MHz
Communication type .....	Bidirectional
Communication Protocol .....	NATRON TTE
Radio signal modulation type .....	GFSK
Number of frequency channels .....	6 pair channels
Radiated power .....	≤ 20 mW
Receiver category (EN300-220-1) .....	1.5
Trace attenuation (during the installation) .....	≥ -90dBm
Test transmission message period .....	300s
Number of tone types (selectable from panel/module) .....	32
Power volume (main tone type 27):	
- Low volume .....	~80dB (A) ±6dB@1m
- High volume .....	~92dB (A) ±5dB@1m
Power volume (other tone type):	
- Low volume .....	~75-85dB ±3dB@1m
- High volume .....	~80-95dB ±3dB@1m
Operation temperature .....	-10°C to +55°C
Related humidity resistance (no condensation) .....	(93±3)% @ 40°C
Enclosure box type, color .....	SAN, white transparent
Dimensions (including base) .....	Ø116x90mm
Protection .....	IP31
Weight (including base and batteries) .....	372g
Mounting .....	Wall, VAD device, Indoor use
Standards .....	EN 54-3; EN 54-23; EN 54-25

### A-weighted sound level diagram

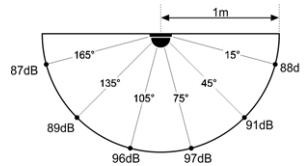

### EN 54-23 VAD (Visual Alarm Device)

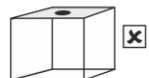
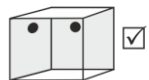

### 3. Installation Place and Mounting

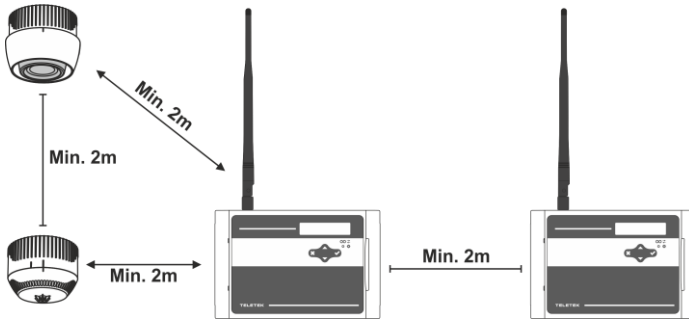

**Attention:**  
For optimum operation, plan to ensure at least 2m distance between two Natron expander modules and the same minimal distance between each device and the expander module.

**Wireless fire base – Dimensions and mounting**

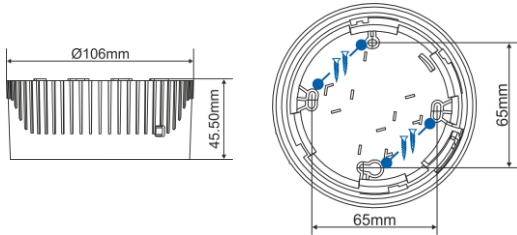

**Dimensions of Natron WSS – Wireless fire base and sounder**

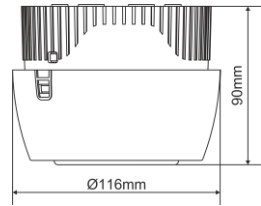

**Disassembling**

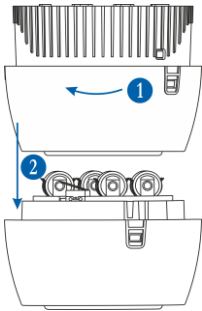

**Locking the sounder to the base**

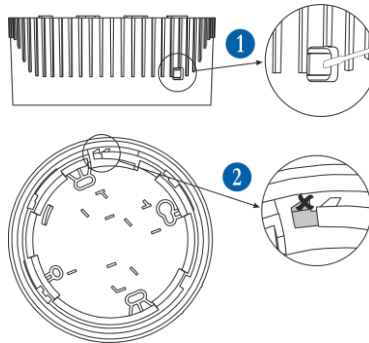

**Unlocking the sounder from the base**

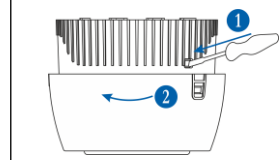

**Assembling**



## 4. PCB Elements

The PCB of Natron WSS is factory mounted and is accessible after disassembling the sounder from the wireless fire base – see item 3.

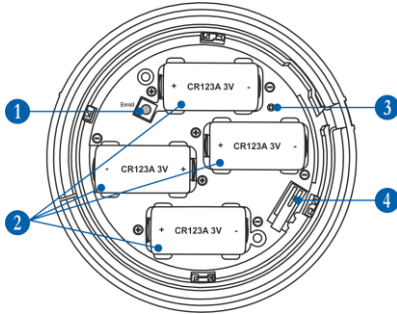

1 – Enroll button. The button is used for the following actions:

- Enrolling the sounder to the expander module.
- Checking the signal strength.
- Reset the sounder.

2 – Power Batteries CR123A 3V

**Attention: Use only batteries from the same type!**

3 – Bi-color operation LED (green/red). The LED is used for following the actions during enrollment, reset and checking the signal strength.

4 – Tamper switch

## 5. Description of Tone Types

Natron WSS supports 32 different alarm tone types. The tone type is set from the programming menu of the expander module (conventional fire alarm systems) or programming the sounders made in the menus of the addressable fire alarm panel. The sound volume level varies with the tone type selected.

The main tone type of Natron WSS is 27.

Tone	Tone Type	Tone Description/Application
1		970Hz
2		800Hz/970Hz @ 2Hz
3		800Hz - 970Hz @ 1Hz
4		970Hz 1s OFF/1s ON
5		970Hz, 0.5s/ 630Hz, 0.5s
6		554Hz, 0.1s/ 440Hz, 0.4s (AFNOR NF S 32 001)
7		500 - 1200Hz, 3.5s/ 0.5s OFF (NEN 2575:2000)
8		420Hz 0.625s ON/0.625s OFF (Australia AS1670 Alert tone)
9		500 - 1200Hz, 0.5s/ 0.5s OFF x 3/ 1.5s OFF (AS1670 Evacuation)
10		550Hz/440Hz @ 0.5Hz
11		970Hz, 0.5s ON/0.5s OFF x 3/ 1.5s OFF (ISO 8201)
12		2850Hz, 0.5s ON/0.5s OFF x 3/ 1.5s OFF (ISO 8201)
13		1200Hz - 500Hz @ 1Hz (DIN 33 404)
14		400Hz
15		550Hz, 0.7s/1000Hz, 0.33s

Tone	Tone Type	Tone Description/Application
17		750Hz
18		2400Hz
19		660Hz
20		660Hz 1.8s ON/1.8s OFF
21		660Hz 0.15s ON/0.15s OFF
22		510Hz, 0.25s/ 610Hz, 0.25s
23		800/1000Hz 0.5s each (1Hz)
24		250Hz - 1200Hz @ 12Hz
25		500Hz - 1200Hz @ 0.33Hz
26		2400Hz - 2900Hz @ 9Hz
27		2400Hz - 2900Hz @ 3Hz 2500Hz (main sound frequency)
28		800Hz - 970Hz @ 100Hz
29		800Hz - 970Hz @ 9Hz
30		800Hz - 970Hz @ 3Hz
31		800Hz, 0.25s ON/1s OFF
32		600Hz - 1100Hz, 2.6s/0.4s OFF

## 6. Enrolling to Expander Module

1. Remove the wireless fire base to access the PCB with the batteries compartment. If the device is not new, perform reset as described in item 7.

2. Enter in programming mode of the Natron expander module. Select ADD DEVICE menu and press ENTER button. A list with already enrolled devices is shown on the screen with an order number and type of the device.

3. Scroll down to find a free address to enroll the sounder. Every free address is labeled as EMPTY.

4. Press ENTER button. Message SEARCHING >>> (arrows are blinking) appears on the screen showing that the module is scanning for signals from a wireless device in its covering range.

**Note:** If there is no signal from the device in 2-minute period, the expander module will exit automatically the programming mode.

5. Power on the sounder. If the device is new just remove the protective folio from the batteries – the enrolling process starts automatically. If the device is powered and reset - single press the ENROLL button. The operation LED (item 4, position 3) starts flashing in red.

6. In case of successful enrolment, the operation LED flashes 3 times in green and message DONE appears for a while on the screen of the module. The sounder is added to the list as WSS type.

7. Test the signal strength between the sounder and the expander module. Single press the ENROLL button and wait for the operation LED indication:

- 3 flashes in green – excellent signal strength;
- 3 flashes in orange – good signal strength, but, if possible, change the place of installation;
- 3 flashes in red – poor signal strength and it is obligatory to change the place of installation.

You can also check the signal quality for the device in DEVICE RSSI menu of the module - item 8.

8. If the signal quality and strength are excellent or good, you can proceed with mounting.

9. Use appropriate fixing elements to mount the wireless fire base to the place of installation. Follow the instructions in item 3 to lock the sounder to the fire base if this is needed.

10. Place the sounder in the base as observe the two short marks to coincide. Move the sounder's body up to hide the marks. Rotate the sounder on clock side until a click is heard.

## 7. Reset of the Sounder

If the sounder is not new, you have to reset it before enrolment to the expander module. Check the batteries condition. It is recommended to change all of them with a brand new.

To reset the Natron WSS, power it on with the batteries and after that press and hold ENROLL button for 5-7 seconds. The reset is complete when the operation LED flashes 3 times in green, followed from 1 long flash in red and 1 long flash in green. Next pressing of ENROLL button will start the enrolment procedure to expander module.

## 8. Checking the Signal Quality (RSSI)

The quality of the signal between the sounder and the expander module is checked at DEVICE RSSI menu of the module. The signal quality is assessed in [dB].

1. Enter in programming mode of the module. Scroll to menu DEVICE RSSI and press ENTER button. A list with present enrolled devices is shown on the screen with an order number and type of the device.

2. Find in the list the sounder number.

3. Press ENTER button. Refer to the table below to read the signal quality on the screen:

Signal quality	Level RSSI	Description
< -90 dB	Loss	Bad signal or no connection.
-90 ÷ -70 dB	Good	The signal is satisfactory but needs improvement. It is recommended to change the installation place of the device.
> -70 dB	Excellent	Excellent signal.

4. You can exit the menu at any time with pressing CANCEL button.

## 9. Finding the Sounder Installation Place and Test

This is a procedure that helps the engineer to find the exact location of every wireless device in the fire installation and test the connection with module.

1. Enter in programming mode of the module. Scroll to menu FIND DEVICE and press ENTER button. A list with present enrolled devices is shown on the screen with an order number and type of the device.

2. Find in the list the sounder number which you want to locate in the fire installation.

3. Press ENTER button. Message FINDING >>> (arrows are blinking) appears on the screen showing that the module is scanning for signals from the selected wireless device. The message will change for a while to FINDING DONE in case of success.

4. The sounder will respond with active strobe and short sound signals.

5. The module will exit automatically the finding procedure after 70-80 seconds. You can also stop the procedure at any time with pressing CANCEL button.

## 10. Replacing Batteries

It is recommended to change the batteries after 8 years of operation regardless of their indicated discharge level. Always use only batteries approved by the manufacturer - Panasonic CR123A 3V or other with similar characteristics. **Attention:** After indication from the panel/expander module for low battery of a device, the user/installer must replace the discharged batteries with new within one month. The remaining shelf time of the new batteries must not be less than 6 years.

1. Disable the sounder operation to avoid fault messages.

2. Disassemble the sounder as described in item 3.

3. Remove the old batteries and place the new as observe the +/- polarity.

4. Assemble the sounder back in place.

5. Enable the sounder operation.

6. Check the signal quality in DEVICE RSSI menu of the expander module.

7. Test the sounder operability.

**CAUTION:** Do not expose used batteries to fire, hot ovens, or mechanical crushing/cutting as this can result in an explosion. Exposing batteries to extremely high environmental temperatures or low air pressure can result in explosion or the leakage of flammable liquid or gas.

**DISPOSAL:** Follow local regulations regarding disposal of the batteries.